

Round Type LED lamp

BL-L312

Features:

- 3mm Round Type LED Lamps.
- Ultra brightness.
- Choice of various viewing angles.
- Diffused, Transparent and Water clear lens are available.
- IC compatible /Low current capability.
- RoHs Compliance



■ Electrical-optical characteristics: (Ta=25°C) (Test Condition: IF=20mA)

Part Number	Chip			Lens Type	Forward Voltage(VF) Unit:V		Luminous Intensity (Iv) Unit:mcd		Viewing Angle 2θ1/2 (deg)
	Emitted Color	Material	λ _P (nm)		Typ	Max	Min.	Typ.	
					BL-L312SRW	Hi Red	AlGaAs,SH	660	
BL-L312LRW	Super Red	AlGaAs,DH	660	1.85	2.20	80	200		
BL-L312URW	Ultra Red	AlGaAs,DDH	660	1.95	2.20	200	350		
BL-L312UEW	Ultra Orange	AlGaInP	630	2.10	2.50	500	800		
BL-L312UYW	Ultra Yellow	AlGaInP	590	2.10	2.50	400	900		
BL-L312UGW	Ultra Green	AlGaInP	574	2.20	2.50	100	250		
BL-L312PGW	Ultra Pure Green	InGaN	525	3.80	4.50	800	2000		
BL-L312BGW	Ultra Bluish Green	InGaN	505	3.80	4.50	400	1500		
BL-L312BW	Blue	InGaN	430	3.80	4.50	200	500		
BL-L312UBW	Ultra Blue	InGaN	470	2.70	4.20	250	1000		
BL-L312WW	UV	InGaN	405	3.80	4.50	40	80		
BL-L312UWW	Ultra White	InGaN	/	2.70	4.20	500	1000		

■ Absolute maximum ratings (Ta=25°C)

Parameter	SR	LR	UR	UE	UY	UG	PG	BG	B	UB	UV	W	Unit
Forward Current I _F	25	25	25	30	30	30	30	30	30	30	30	30	mA
Power Dissipation P _d	60	60	60	65	65	75	110	110	120	120	120	120	mW
Reverse Voltage V _R	5	5	5	5	5	5	5	5	5	5	5	5	V
Peak Forward Current I _{PF} (Duty 1/10 @1KHZ)	150	150	150	150	150	150	150	150	100	100	100	100	mA
Operation Temperature T _{OPR}	-40 to +80												°C
Storage Temperature T _{STG}	-40 to +85												°C
Lead Soldering Temperature TSOL	Max.260±5 °C for 3 sec Max. (1.6mm from the base of the epoxy bulb)												°C

Round Type LED lamp

BL-L312

■ Package configuration & Internal circuit diagram

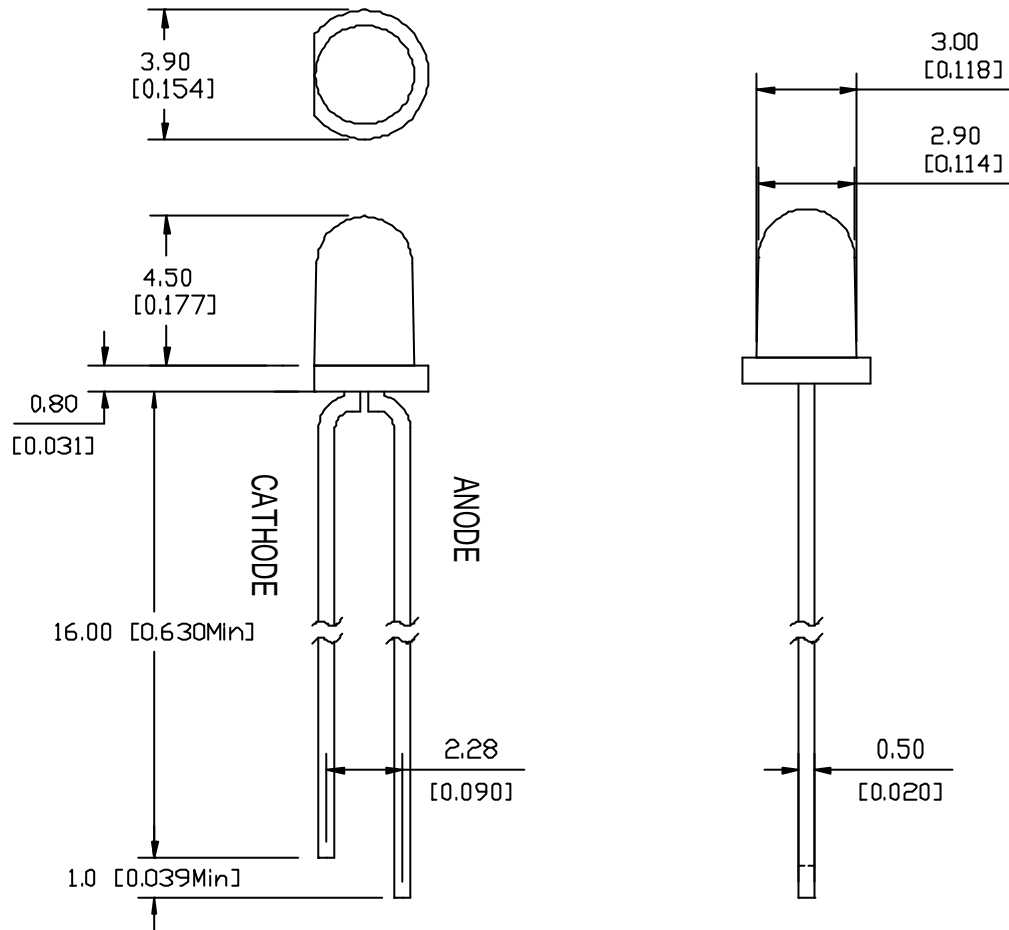

Notes:

1. All dimensions are in millimeters (inches)
2. Tolerance is $\pm 0.25(0.01)$ unless otherwise noted.
3. Specifications are subject to change without notice.

Round Type LED lamp

BL-L312

Typical electrical-optical characteristics curves:

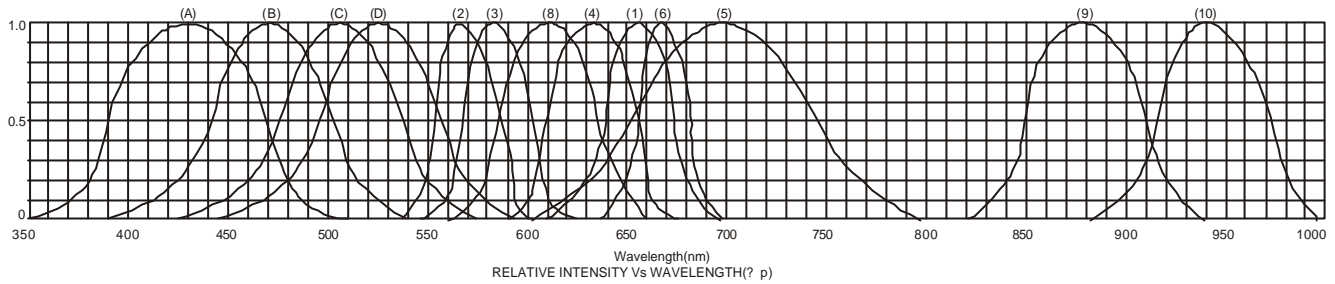

- (1) - GaAsP/GaAs 655nm/Red
- (2) - GaP 570nm/Yellow Green
- (3) - GaAsP/GaP 585nm/Yellow
- (4) - GaAsP/GaP 635nm/Orange & Hi-Eff Red
- (5) - GaP 700nm/Bright Red
- (6) - GaAlAs/GaAs 660nm/Super Red
- (8) - GaAsP/GaP 610nm/Super Red
- (9) - GaAlAs 880nm
- (10) - GaAs/GaAs & GaAlAs/GaAs 940nm
- (A) - GaN/SiC 430nm/Blue
- (B) - InGaN/SiC 470nm/Blue
- (C) - InGaN/SiC 505nm/Ultra Green
- (D) - InGaAl/SiC 525nm/Ultra Green

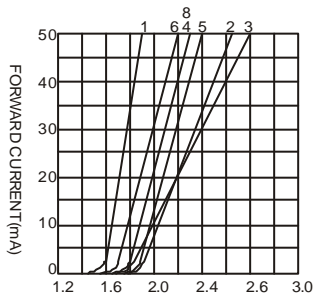

FORWARD VOLTAGE (Vf)
FORWARD CURRENT VS.
FORWARD VOLTAGE

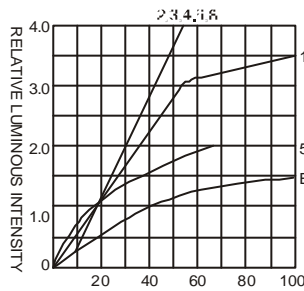

FORWARD CURRENT (mA)
RELATIVE LUMINOUS
INTENSITY VS. FORWARD
CURRENT

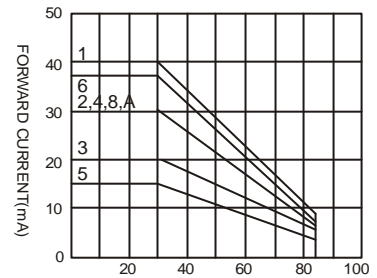

AMBIENT TEMPERATURE Ta()
FORWARD CURRENT VS. AMBIENT
TEMPERATURE

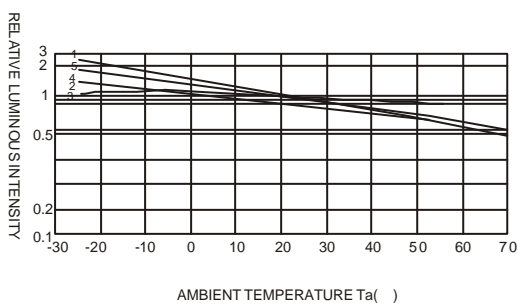

AMBIENT TEMPERATURE Ta()

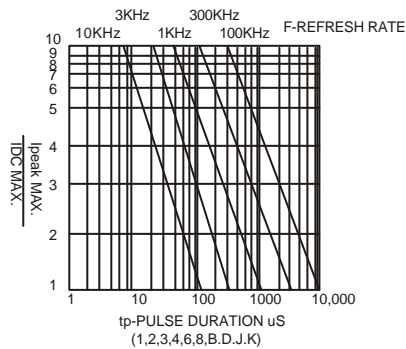

tp-PULSE DURATION µS
(1,2,3,4,6,8,B,D,J,K)

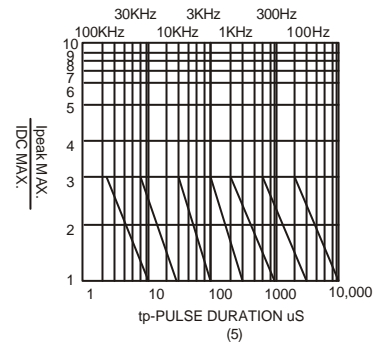

(5)

NOTE:25 free air temperature unless otherwise specified

Round Type LED lamp

BL-L312

■ Packing and weighting

