

## Round Type LED lamp

BL-L314

### Features:

- 3mm Round Type LED Lamps.
- Ultra brightness.
- Choice of various viewing angles.
- Diffused, Transparent and Water clear lens are available.
- IC compatible /Low current capability.
- RoHs Compliance



### Electrical-optical characteristics: (Ta=25°C) (Test Condition: IF=20mA)

Part Number	Chip			Lens Type	Forward Voltage(VF) Unit:V		Luminous Intensity (lv) Unit:mcd		Viewing Angle 2θ/2(deg)
	Emitted Color	Material	λP (nm)		Typ	Max	Min.	Typ.	
					BL-L314HD	Red	GaP/GaP	700	
BL-L314ED	Orange	GaAsP/GaP	635	Water Clear	2.10	2.50	2	20	30
BL-L314SRC	Hi Red	AlGaAs,SH	660		1.85	2.20	50	220	
BL-L314LRC	Super Red	AlGaAs,DH	660		1.85	2.20	200	500	
BL-L314URC	Ultra Red	AlGaAs,DDH	660		1.95	2.20	500	900	
BL-L314UEC	Ultra Orange	AlGaInP	630		2.10	2.50	900	1800	
BL-L314UYC	Ultra Yellow	AlGaInP	590		2.10	2.50	900	2000	
BL-L314UGC	Ultra Green	AlGaInP	574		2.20	2.50	220	600	
BL-L314PGC	Ultra Pure Green	InGaN	525		3.80	4.50	1200	3000	
BL-L314BGC	Ultra Bluish Green	InGaN	505		3.80	4.50	900	2800	
BL-L314UBC	Ultra Blue	InGaN	470		2.70	4.20	500	1400	
BL-L314VC	UV	InGaN	405		3.80	4.50	100	150	
BL-L314UWC	Ultra White	InGaN	/		2.70	4.20	900	2000	

### Absolute maximum ratings (Ta=25°C)

Parameter	E	SR	LR	UR	UE	UY	UG	PG	BG	UB	UV	W	Unit
Forward Current I <sub>F</sub>	25	25	25	25	30	30	30	30	30	30	30	30	mA
Power Dissipation P <sub>d</sub>	60	60	60	60	65	65	75	110	110	120	120	120	mW
Reverse Voltage V <sub>R</sub>	5	5	5	5	5	5	5	5	5	5	5	5	V
Peak Forward Current I <sub>PF</sub> (Duty 1/10 @1KHZ)	150	150	150	150	150	150	150	150	100	100	100	100	mA
Operation Temperature T <sub>OPR</sub>	-40 to +80												°C
Storage Temperature T <sub>STG</sub>	-40 to +85												°C
Lead Soldering Temperature TSOL	Max.260±5°C for 3 sec Max. (1.6mm from the base of the epoxy bulb)												°C

## Round Type LED lamp

BL-L314

### Package configuration & Internal circuit diagram

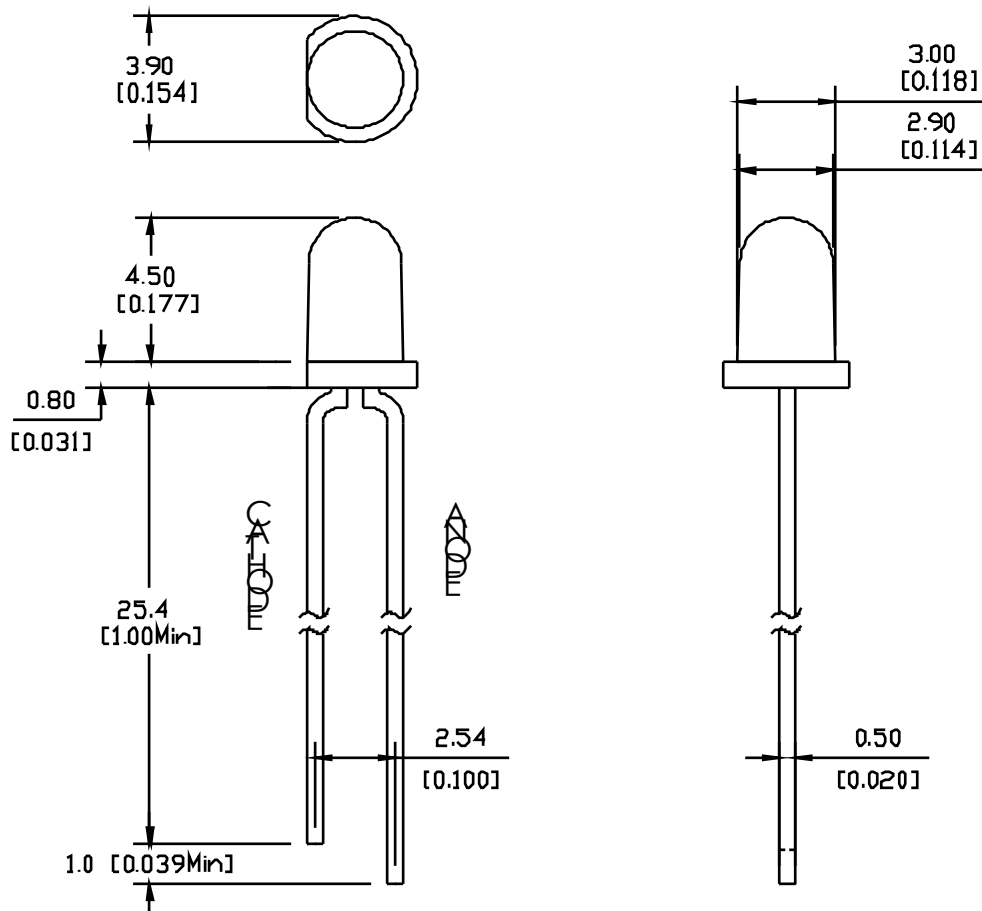

#### Notes:

1. All dimensions are in millimeters (inches)
2. Tolerance is  $\pm 0.25$  (0.01") unless otherwise noted.
3. Specifications are subject to change without notice.

# Round Type LED lamp

BL-L314

## Typical electrical-optical characteristics curves:

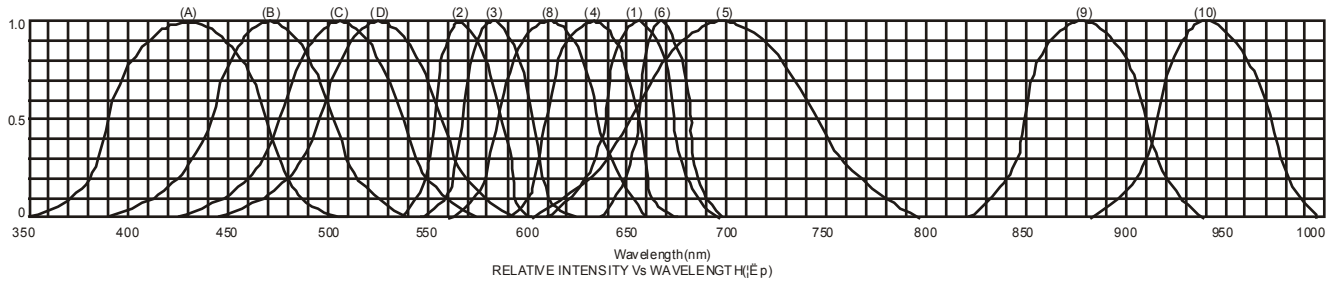

- (1) - GaAsP/GaAs 655nm/Red
- (2) - GaP 570nm/Yellow Green
- (3) - GaAsP/GaP 585nm/Yellow
- (4) - GaAsP/GaP 635nm/Orange & Hi-Eff Red
- (5) - GaP 700nm/Bright Red
- (6) - GaAlAs/GaAs 660nm/Super Red
- (8) - GaAsP/GaP 610nm/Super Red
- (9) - GaAlAs 880nm
- (10) - GaAs/GaAs & GaAlAs/GaAs 940nm
- (A) - GaN/SiC 430nm/Blue
- (B) - InGaN/SiC 470nm/Blue
- (C) - InGaN/SiC 505nm/Ultra Green
- (D) - InGaAlSiC 525nm/Ultra Green

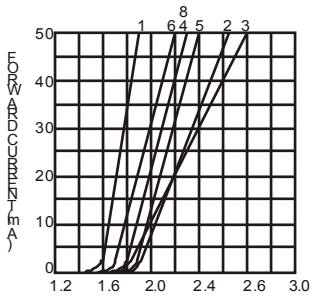

FORWARD VOLTAGE (Vf)  
FORWARD CURRENT VS.  
FORWARD VOLTAGE

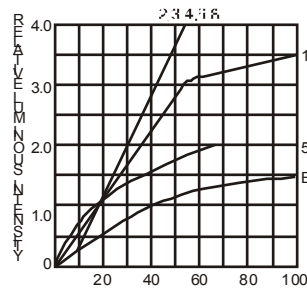

FORWARD CURRENT (mA)  
RELATIVE LUMINOUS  
INTENSITY VS. FORWARD  
CURRENT

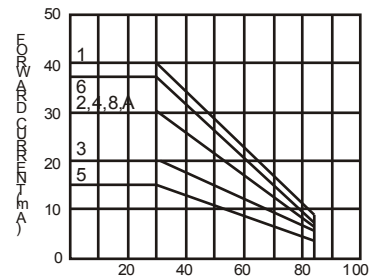

AMBIENT TEMPERATURE Ta(°C)  
FORWARD CURRENT VS. AMBIENT  
TEMPERATURE

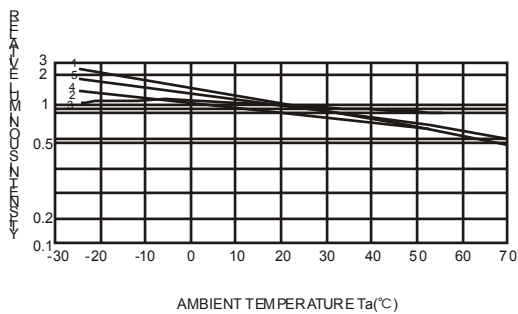

AMBIENT TEMPERATURE Ta(°C)

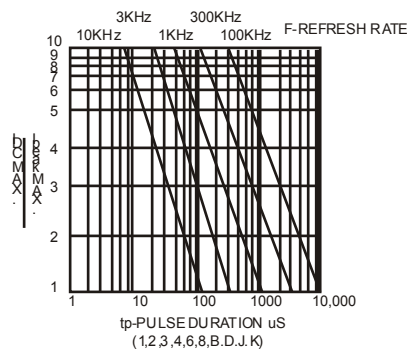

tp-PULSE DURATION  $\mu$ s  
(1,2,3,4,6,8,B,D,J,K)

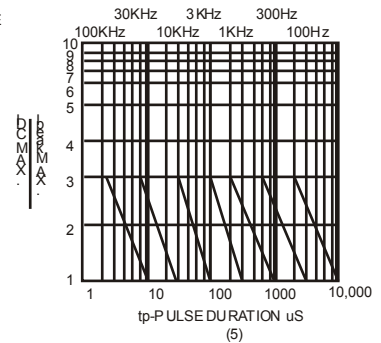

(5)

NOTE: 25°C free air temperature unless otherwise specified

Round Type LED lamp

BL-L314

Packing and weighting

